

## Heater Bands

HUGE SELECTION OF HEATER BANDS  
READY TO SHIP TODAY

Over  
20,000  
in Stock!



**CONSTRUCTION:**

- All construction types are shown and stocked with 12" (length) leads, unless otherwise noted.
- Standard Barrel Nuts ( $\frac{3}{8}$ " high) are normally supplied on bands 1 $\frac{1}{2}$ " I.D. or larger.

**We have a wide variety of sizes and constructions IN STOCK and ready to ship the same day.**

**If your heater band isn't on the shelf,**

CALL TODAY FOR  
MORE INFORMATION  
ON



**800-627-1033**

## Quotation Requests

### NEED A QUICK QUOTE?

In a hurry for a quote? Services For Plastics, Inc. has a solution. To expedite your quotation request, you can now request a quote on-line. Simply visit our website and click "REQUEST A QUOTE." Select the desired product, then complete and submit the form. It's convenient, quick and simple to use!

*quick*QUOTE

[www.servicesforplastics.com](http://www.servicesforplastics.com)

Get A Quote in  
24 Hours or Less

***TRY IT TODAY!***

# Heater Bands



Manufactured from  
**TOP QUALITY**  
Mica Insulation  
and Materials

***Many sizes and constructions in stock,  
or we can build a band to your specifications!***

***Competitive pricing on a full-line of top quality bands!***

## Construction Notes:

- All construction types shown are stocked with 12" (length) leads, unless otherwise noted.
- Standard Barrel Nuts ( $\frac{3}{8}$ " high) are normally supplied on bands  $1\frac{1}{2}$ " I.D. or larger.
- We supply a Low Profile Barrel Nut Strap ( $\frac{7}{32}$ " high) on bands under  $1\frac{1}{2}$ " I.D.

## When ordering, please specify the following information:

- Quantity and Part Number (if known)
- Inside Diameter (I.D.)
- Width (W)
- Voltage (2-pc. construction; specify total voltage)
- Wattage (2-pc. construction; specify total wattage)
- Basic Construction Type (A-Z)
- Lead Lengths Desired (stock length 12") or Post Terminals (10-24 thread size)
- Any Special Options Required

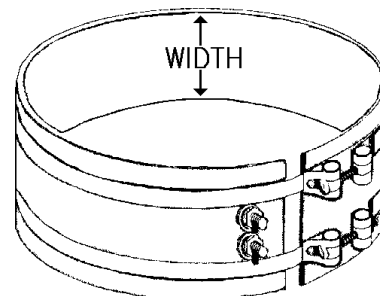
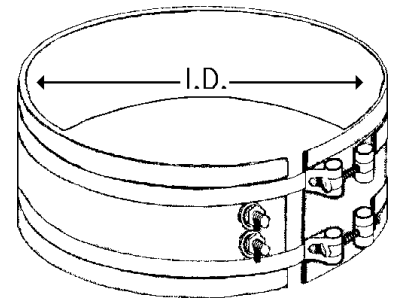

*SFP reserves the right to oversee special order standard, mica, and economy heater bands.*

# Heater Bands...Configurations

Type A



**Barrel Nut Strap**  
Metal braid leads exit from both sides of gap.

Type B



**Barrel Nut Strap**  
Non-metal braid leads exit from both sides of gap.

Type C



**Barrel Nut Strap**  
Leads exit from one side of gap through outside surface of heater. *Options 1,2,3.\**

Type D



**Barrel Nut Strap**  
Leads exit from edge on opposite side from gap. *Options 2,3.\**

Type E



**Barrel Nut Strap**  
Leads exit from each side of gap through inside. *Option 3 only.\**

Type F



**Flange Lock-up**  
Leads exit from both sides of gap through edge. *Options 2,3.\*^*

Type G



**Barrel Nut Strap**  
Metal braid leads exit from edge on one side of gap.

Type H



**Barrel Nut Strap**  
1 pc.; One post terminal on each side of gap.

Type I



**Barrel Nut Strap**  
2 pc.; Post terminals at each end of heater.

Type J



**Barrel Nut Strap**  
1 pc.; Two post terminals on one side of gap.

Type K



**Barrel Nut Strap**  
2 pc.; Two post terminals on each side of gap.

Type L



**Barrel Nut Strap**  
Expandable; *Options 1,2,3,16.\**

Type M



**Barrel Nut Strap**  
Cushioned clamping strap partially covers heater. *Options 1,2,3,16.\**

Type N



**Flange Lock-up**  
1 pc.; Leads exit from one side of gap through outside surface of heater. *Options 1,2,3.\*^*

Type O



**Flange Lock-up**  
2 pc.; Leads exit from both sides of gap through outside surface of heater. *Options 1,2,3.\*^*

Type P



**Tapered Wedge Lock**  
Leads exit from both sides of gap through edge. *Options 2,3.\**

\*See *Optional Features* on following page.

^See *"NOTE"* on following page.

# Heater Bands...Configurations

Type Q



**Flange Lock-up**  
Hinged; Post terminals at each end of heater.^

Type R



**Flange Lock-up**  
Hinged; Two post terminals on each side of

Type S



**Flange Lock-up**  
Hinged; Leads exit from both sides of gap through outside surface of heater.

Type T



**Flange Lock-up**  
1 pc.; One post terminal on each side of gap.^

Type U



**Flange Lock-up**  
2 pc.; Post terminals at each end of heater.^

Type V



**Flange Lock-up**  
1 pc.; Two post terminals on one side of gap.^

Type W



**Flange Lock-up**  
2 pc.; Two post terminals on each side of gap.^

Type X



**Extended Flange with Electrical Connections**  
1 pc.; *Options*

Type Y



**Extended Flange with Electrical Connections**  
2 pc.; *Options*

Type Z



**Hexagonal Band Heater**  
Leads exit from both sides of gap through edge.

**^NOTE:** ON FLANGED BANDS, when post terminals are specified at the same end of the band, they will normally be located as follows: bands under 2" wide, post terminals will be placed tandem, around the circumference of the band; bands 2" wide and over, post terminals will be placed across the width of the band.

## \*Optional Features:

1. Flexible Armor (BX) Installed Over Flexible Leads
2. Metal Braid Installed Over Flexible Leads
3. Flexible Fiberglass Leads (Insulated Nickel or Nickel-clad Conductor) Installed with 2" Fiberglass Boot
4. Low Profile Band, Presized for Slip Fit by Installation of Punch Lock Straps
5. Terminal Box
6. Flexible Armor in Right Angle Bracket
7. Thermocouple Hole
8. Button Terminals
9. Appliance Pins
10. Twist Lock Plug Installed on Leads
11. Extra Wide Gap (specify)
12. Grounding Stud
13. Dual Voltage (specify)
14. Stainless Steel Sheath
15. Low Profile Strap (specify this option only if desired on sizes where not normally supplied)
16. Post Terminals

For information and pricing on other sizes and types of heaters not listed, call SFP at 1-800-627-1033.

# Standard Mica Heater Bands...continued

PART NO.	I.D.	WIDTH	TOTAL VOLTS	TOTAL WATTS	CONSTRUCTION TYPE	PRICE EACH	
						1-5	6-11+
OMS003B	1"	1"	120	100	Type B - 12" Flexible Leads		
OMS065P3	1"	1"	120	100	Type P3 Wedge - 12" Flexible Leads		
OMS068B	1"	1"	120	125	Type B - 12" Flexible Leads		
OMS069A	1"	1"	240	100	Type A - 12" Stainless Steel Leads		
OMS098A	1"	1"	240	100	Type A - 24" Stainless Steel Leads		
OMS004B	1"	1"	240	100	Type B - 12" Flexible Leads		
OMS066P3	1"	1"	240	100	Type P3 Wedge - 12" Flexible Leads		
OMS067B	1"	1"	240	125	Type B - 12" Flexible Leads		
OMS005B	1"	1½"	120	150	Type B - 12" Flexible Leads		
OMS006B	1"	1½"	240	150	Type B - 12" Flexible Leads		
OMS072B	1"	1½"	240	150	Type B - 18" Flexible Leads		
OMS070P2	1"	1½"	240	150	Type P2 Wedge - 12" SS Leads		
OMS071P3	1"	1½"	240	175	Type P3 Wedge - 12" Flexible Leads		
OMS007B	1"	2"	120	200	Type B - 12" Flexible Leads		
OMS075A	1"	2"	240	200	Type A - 12" Stainless Steel Leads		
OMS008B	1"	2"	240	200	Type B - 12" Flexible Leads		
OMS073P2	1"	2"	240	200	Type P2 Wedge - 12" SS Leads		
OMS010B	1"	2½"	240	250	Type B - 12" Flexible Leads		
OMS011B	1"	3"	120	300	Type B - 12" Flexible Leads		
OMS012B	1"	3"	240	300	Type B - 12" Flexible Leads		
OMS076B	1"	3"	240	350	Type B - 12" Flexible Leads		
OMS013B	1"	4"	120	400	Type B - 12" Flexible Leads		
OMS014B	1"	4"	240	400	Type B - 12" Flexible Leads		
OMS015B	1"	5"	120	500	Type B - 12" Flexible Leads		
OMS016B	1"	5"	240	500	Type B - 12" Flexible Leads		
OMS149A	1"	4"	240	400	Type A - 48" Stainless Steel Leads		
OMS150A	1"	6"	240	625	Type A - 48" Stainless Steel Leads		
OMS017B	1¼"	1"	120	125	Type B - 12" Flexible Leads		
OMS018B	1¼"	1"	240	125	Type B - 12" Flexible Leads		
OMS019B	1¼"	1½"	120	200	Type B - 12" Flexible Leads		
OMS020B	1¼"	1½"	240	200	Type B - 12" Flexible Leads		
OMS021B	1¼"	2"	120	250	Type B - 12" Flexible Leads		
OMS022B	1¼"	2"	240	250	Type B - 12" Flexible Leads		
OMS119B	1¼"	2½"	240	350	Type B - 12" Flexible Leads		
OMS023B	1¼"	3"	120	400	Type B - 12" Flexible Leads		
OMS024B	1¼"	3"	240	400	Type B - 12" Flexible Leads		
OMS025B	1⅜"	1"	120	200	Type B - 12" Flexible Leads		
OMS026B	1⅜"	1"	240	200	Type B - 12" Flexible Leads		
OMS027B	1⅜"	1½"	120	200	Type B - 12" Flexible Leads		
OMS028B	1⅜"	1½"	240	200	Type B - 12" Flexible Leads		
OMS029B	1⅜"	2"	120	300	Type B - 12" Flexible Leads		
OMS030B	1⅜"	2"	240	300	Type B - 12" Flexible Leads		
OMS185B	1⅜"	⅝"	120	100	Type B - 12" Flexible Leads		
OMS031B	1½"	½"	120	100	Type B - 12" Flexible Leads		
OMS032B	1½"	½"	240	100	Type B - 12" Flexible Leads		
OMS033B	1½"	1"	120	150	Type B - 12" Flexible Leads		

Call for Pricing 800-627-1033

Flex. Lds. = Flexible Leads

SS Lds. = Stainless Steel Leads

\*Indicates direct replacement for Van Dorn bands.



# Standard Mica Heater Bands...continued

PART NO.	I.D.	WIDTH	TOTAL VOLTS	TOTAL WATTS	CONSTRUCTION TYPE	PRICE EACH	
						1-5	6-11+
OMS034B	1½"	1"	240	150	Type B - 12" Flexible Leads		
OMS103B	1½"	1¼"	240	250	Type B - 12" Flexible Leads		
OMS038A	1½"	1½"	120	275	Type A - 12" Stainless Steel Leads		
OMS036B	1½"	1½"	120	275	Type B - 12" Flexible Leads		
OMS077P3	1½"	1½"	120	275	Type P3 Wedge - 12" Flexible Leads		
OMS099A*	1½"	1½"	230	275	Type A - 54" Stainless Steel Leads		
OMS035B	1½"	1½"	240	250	Type B - 12" Flexible Leads		
OMS074B	1½"	1½"	240	250	Type B - 36" Flexible Leads		
OMS039A	1½"	1½"	240	275	Type A - 12" Stainless Steel Leads		
OMS102A	1½"	1½"	240	275	Type A - 18" Stainless Steel Leads		
OMS037B	1½"	1½"	240	275	Type B - 12" Flexible Leads		
OMS078P3	1½"	1½"	240	275	Type P3 Wedge - 12" Flexible Leads		
OMS200B	1½"	1½"	240	275	Type B - 24" Flexible Leads		
OMS080A	1½"	1½"	240	300	Type A - 12" Stainless Steel Leads		
OMS040B	1½"	2"	120	300	Type B - 12" Flexible Leads		
OMS107P3	1½"	2"	120	300	Type P3 Wedge - 12" Flexible Leads		
OMS108P3	1½"	2"	240	300	Type P3 Wedge - 12" Flexible Leads		
OMS082A	1½"	2"	240	300	Type A - 12" Stainless Steel Leads		
OMS041B	1½"	2"	240	300	Type B - 12" Flexible Leads		
OMS042B	1½"	2½"	120	400	Type B - 12" Flexible Leads		
OMS114A	1½"	2½"	240	400	Type A - 36" Stainless Steel Leads		
OMS043B	1½"	2½"	240	400	Type B - 12" Flexible Leads		
OMS140B	1½"	2½"	480	300	Type B - 12" Flexible Leads		
OMS191A	1½"	2½"	240	450	Type A - 36" Stainless Steel Leads		
OMS084B	1½"	3"	120	400	Type B - 12" Flexible Leads		
OMS044B	1½"	3"	120	450	Type B - 12" Flexible Leads		
OMS045B	1½"	3"	240	450	Type B - 12" Flexible Leads		
OMS083P3	1½"	3"	240	450	Type P3 Wedge - 12" Flexible Leads		
OMS194B	1½"	3"	240	450	Type B - 48" Flexible Leads		
OMS188B	1½"	3"	460	450	Type B - 12" Flexible Leads		
OMS046B	1½"	3½"	120	525	Type B - 12" Flexible Leads		
OMS047B	1½"	3½"	240	525	Type B - 12" Flexible Leads		
OMS048B	1½"	4"	120	550	Type B - 12" Flexible Leads		
OMS086B	1½"	4"	240	500	Type B - 12" Flexible Leads		
OMS049B	1½"	4"	240	550	Type B - 12" Flexible Leads		
OMS112P3	1½"	5"	120	650	Type P3 Wedge - 12" Flexible Leads		
OMS050B	1½"	5"	120	700	Type B - 12" Flexible Leads		
OMS113P3	1½"	5"	240	650	Type P3 Wedge - 12" Flexible Leads		
OMS051B	1½"	5"	240	700	Type B - 12" Flexible Leads		
OMS087B	1½"	6"	120	850	Type B - 12" Flexible Leads		
OMS088B	1½"	6"	240	850	Type B - 12" Flexible Leads		
OMS052B	1¾"	1"	120	175	Type B - 12" Flexible Leads		
OMS053B	1¾"	1"	240	175	Type B - 12" Flexible Leads		
OMS054B	1¾"	1½"	120	250	Type B - 12" Flexible Leads		

**Call for Pricing 800-627-1033**

**Flex. Lds. = Flexible Leads**

**SS Lds. = Stainless Steel Leads**

**\*Indicates direct replacement for Van Dorn bands.**



# Standard Mica Heater Bands...continued

PART NO.	I.D.	WIDTH	TOTAL VOLTS	TOTAL WATTS	CONSTRUCTION TYPE	PRICE EACH	
						1-5	6-11+
OMS091B	1 3/4"	1 1/2"	120	300	Type B - 12" Flexible Leads		
OMS055B	1 3/4"	1 1/2"	240	250	Type B - 12" Flexible Leads		
OMS090B	1 3/4"	1 1/2"	240	300	Type B - 12" Flexible Leads		
OMS056B	1 3/4"	2"	120	350	Type B - 12" Flexible Leads		
OMS057B	1 3/4"	2"	240	350	Type B - 12" Flexible Leads		
OMS092B	1 3/4"	2"	240	400	Type B - 12" Flexible Leads		
OMS058B	1 3/4"	2 1/2"	120	350	Type B - 12" Flexible Leads		
OMS059B	1 3/4"	2 1/2"	240	350	Type B - 12" Flexible Leads		
OMS060B	1 3/4"	3"	120	500	Type B - 12" Flexible Leads		
OMS061B	1 3/4"	3"	240	500	Type B - 12" Flexible Leads		
OMS116A	1 3/4"	4"	240	400	Type A - 24" Stainless Steel Leads		
OMS115B	1 3/4"	4"	240	700	Type B - 12" Flexible Leads		
OMS062B	1 3/4"	5"	120	900	Type B - 12" Flexible Leads		
OMS063B	1 3/4"	5"	240	900	Type B - 12" Flexible Leads		
2MS001B	2"	1"	120	200	Type B - 12" Flexible Leads		
2MS002B	2"	1"	240	200	Type B - 12" Flexible Leads		
OMS078B	2"	1"	240	300	Type B - 12" Flexible Leads		
2MS003B	2"	1 1/2"	120	300	Type B - 12" Flexible Leads		
2MS004B	2"	1 1/2"	240	300	Type B - 12" Flexible Leads		
2MS005B	2"	2"	120	400	Type B - 12" Flexible Leads		
2MS006B	2"	2"	240	400	Type B - 12" Flexible Leads		
2MS031C2	2"	2"	240	400	Type C - 24" Stainless Steel Leads		
2MS041H	2"	2"	240	400	Type H - Post Terminals		
2MS007B	2"	2 1/2"	120	500	Type B - 12" Flexible Leads		
2MS008B	2"	2 1/2"	240	500	Type B - 12" Flexible Leads		
2MS009B	2"	3"	120	600	Type B - 12" Flexible Leads		
2MS010B	2"	3"	240	600	Type B - 12" Flexible Leads		
2MS044A	2"	4"	240	400	Type A - 12" Stainless Steel Leads		
2MS011B	2"	5"	120	900	Type B - 12" Flexible Leads		
2MS012B	2"	5"	240	900	Type B - 12" Flexible Leads		
2MS034D	2 1/8"	1"	240	250	Type D - 12" Flexible Leads		
2MS101B	2 1/8"	3"	120	700	Type B - 12" Flexible Leads		
2MS013B	2 1/4"	1"	120	225	Type B - 12" Flexible Leads		
2MS014B	2 1/4"	1"	240	225	Type B - 12" Flexible Leads		
2MS015B	2 1/4"	2"	120	450	Type B - 12" Flexible Leads		
2MS016B	2 1/4"	2"	240	450	Type B - 12" Flexible Leads		
2MS047B	2 1/4"	2 1/2"	120	500	Type B - 12" Flexible Leads		
2MS017B	2 1/4"	3"	120	700	Type B - 12" Flexible Leads		
2MS018B*	2 3/8"	1"	240	250	Type B - 12" Flexible Leads		
2MS035H*	2 3/8"	1"	230	250	Type H - Post Terminals		
2MS045B	2 3/8"	2"	240	500	Type B - 12" Flexible Leads		
2MS036C3*	2 7/16"	1"	230	250	Type C3 - 72" Flexible Leads		
2MS019B	2 1/2"	1"	120	300	Type B - 12" Flexible Leads		
2MS020B	2 1/2"	1"	240	300	Type B - 12" Flexible Leads		

**Call for Pricing**  
**800-627-1033**

Flex. Lds. = Flexible Leads

SS Lds. = Stainless Steel Leads

\*Indicates direct replacement for Van Dorn bands.



# Standard Mica Heater Bands...continued

PART NO.	I.D.	WIDTH	TOTAL VOLTS	TOTAL WATTS	CONSTRUCTION TYPE	PRICE EACH	
						1-5	6-11+
2MS040B	2½"	1¼"	240	300	Type B - 36" Flexible Leads		
2MS021B	2½"	1½"	120	350	Type B - 12" Flexible Leads		
2MS028B	2½"	1½"	240	300	Type B - 12" Flexible Leads		
2MS022B	2½"	1½"	240	350	Type B - 12" Flexible Leads		
2MS059B	2½"	1½"	240	450	Type B - 108" Flexible Leads		
2MS043H	2½"	1½"	240	450	Type H - Post Terminals		
2MS091B	2½"	1½"	480	350	Type B - 12" Flexible Leads		
2MS023B	2½"	2"	120	500	Type B - 12" Flexible Leads		
2MS089H	2½"	2½"	240	500	Type H - Post Terminals		
2MS062B	2½"	2½"	240	550	Type B - 108" Flexible Leads		
2MS099H	2½"	2½"	240	550	Type H - Post Terminals		
2MS024B	2½"	2"	240	500	Type B - 12" Flexible Leads		
2MS025B	2½"	3"	120	700	Type B - 12" Flexible Leads		
2MS026B	2½"	3"	240	700	Type B - 12" Flexible Leads		
2MS042B	2¾"	1"	240	425	Type B - 12" Flexible Leads		
2MS056H	2¾"	1"	240	425	Type H - Post Terminals		
2MS030B	2¾"	1½"	240	400	Type B - 12" Flexible Leads		
2MS032B	2¾"	2"	220	350	Type B - 12" Flexible Leads		
3MS001B	3"	1"	120	300	Type B - 12" Flexible Leads		
3MS023A	3"	1"	230	400	Type A - 36" Stainless Steel Leads		
3MS015H*	3"	1"	230	400	Type H - Post Terminals		
3MS017C3*	3"	1"	230	400	Type C3 - 12" Flexible Leads		
3MS002B	3"	1"	240	300	Type B - 12" Flexible Leads		
3MS011H	3"	1"	240	400	Type H - Post Terminals		
3MS016I*	3"	1"	460	400	Type I - 2 pc. Post Terminals		
3MS014C3*	3"	1"	460	400	Type C3 - 12" Flexible Leads		
3MS003B	3"	1½"	120	500	Type B - 12" Flexible Leads		
3MS018H*	3"	1½"	220	450	Type H - Post Terminals		
3MS025H	3"	1½"	240	300	Type H - Post Terminals		
3MS004B	3"	1½"	240	500	Type B - 12" Flexible Leads		
3MS005H	3"	1½"	240	500	Type H - Post Terminals		
3MS042B	3"	2"	120	550	Type B - 12" Flexible Leads		
3MS028H	3¼"	1½"	240	500	Type H - Post Terminals		
3MS009A	3½"	1½"	240	300	Type A - 60" Stainless Steel Leads		
3MS006H	3½"	1½"	240	500	Type H - Post Terminals		
3MS007B	3½"	2"	120	650	Type B - 12" Flexible Leads		
3MS008H	3½"	2"	240	650	Type H - Post Terminals		
3MS013H	3½"	2"	480	800	Type H - Post Terminals		
3MS019C2	3½"	3¼"	240	1000	Type C2 - 12" Stainless Steel Leads		
3MS012H*	3⅝"	1½"	240	625	Type H - Post Terminals		
3MS010L16	3⅝"	1½"	240	650	Type L - Post Expandable		
4MS001H	4"	1"	120	450	Type H - Post Terminals		
4MS002H*	4"	1"	240	625	Type H - Post Terminals		
4MSA01I	4-4½"	1½"	240	550	Type I - 2 pc. Post Adjustable		
4MS015H*	4"	1½"	220	625	Type H - Post Terminals		
4MS016H*	4"	1½"	230	400	Type H - Post Terminals		
4MSA02I	4-4½"	1½"	480	550	Type I - 2 pc. Post Adjustable		

**Call for Pricing 800-627-1033**

Flex. Lds. = Flexible Leads

SS Lds. = Stainless Steel Leads

\*Indicates direct replacement for Van Dorn bands.





# Standard Mica Heater Bands...continued

PART NO.	I.D.	WIDTH	TOTAL VOLTS	TOTAL WATTS	CONSTRUCTION TYPE	PRICE EACH	
						1-5	6-11+
4MS024A	4"	1½"	240	625	Type A - 12" Stainless Steel Leads		
4MS009H	4"	1½"	240	625	Type H - Post Terminals		
4MS022H	4"	1½"	240	750	Type H - Post Terminals		
4MS017C3*	4"	1½"	460	625	Type C3 - 18" Flexible Leads		
4MS003H	4"	2"	120	800	Type H - Post Terminals		
4MS005H	4"	2"	240	800	Type H - Post Terminals		
4MS004MSP*	4"	2"	460	460	Type M - 2 pc. Special 270° Coverage		
4MS012H	4"	2"	480	800	Type H - Post Terminals		
4MS007H	4"	2"	480	1000	Type H - Post Terminals		
4MS008I	4"	2"	480	1000	Type I - 2 pc. Post Terminals		
4MS006I	4"	4"	480	1000	Type I - 2 pc. Post Terminals		
4MSA03I	4½-5"	1½"	240	650	Type I - 2 pc. Post Adjustable		
4MS011I	4½"	1½"	240	350	Type I - 2 pc. Post Terminals		
4MSA04I	4½-5"	1½"	480	650	Type I - 2 pc. Post Adjustable		
4MS026H	4¾"	2½"	480	900	Type H - Post Terminals		
4MS018I	4¾"	5"	240	1500	Type I - 2 pc. Post Terminals		
4MS029L16	4¾"	5½"	240	2000	Type L - Post Expandable		
4MS019J	4¾"	5½"	460	2000	Type J - Post Terminals		
5MS001H	5"	1"	120	550	Type H - Post Terminals		
5MS002H	5"	1"	240	550	Type H - Post Terminals		
5MSA01I	5-5½"	1½"	240	700	Type I - 2 pc. Post Adjustable		
5MSA02I	5-5½"	1½"	480	700	Type I - 2 pc. Post Adjustable		
5MSA03I	5-5½"	3"	480	1400	Type I - 2 pc. Post Adjustable		
5MS019H	5"	3½"	480	1000	Type H - Post Terminals		
5MS015H	5¼"	1"	240	600	Type H - Post Terminals		
5MS032H	5¼"	1"	460	600	Type H - Post Terminals		
5MS008H*	5¼"	1½"	230	600	Type H - Post Terminals		
5MS009H*	5¼"	1½"	230	1000	Type H - Post Terminals		
5MS006L16	5¼"	1½"	240	600	Type L - Post Expandable		
5MS003H	5¼"	1½"	240	1000	Type H - Post Terminals		
5MS029H	5¼"	1½"	460	600	Type H - Post Terminals		
5MS025L16	5¼"	1½"	460	600	Type L - Post Expandable		
5MS034H	5¼"	1½"	460	1000	Type H - Post Terminals		
5MS010I*	5¼"	1½"	480	600	Type I - 2 pc. Post Terminals		
5MS017I	5¼"	1½"	480	1000	Type I - 2 pc. Post Terminals		
5MS011MSP*	5¼"	2"	460	666	Type M - 2 pc. Special 270° Coverage		
5MS021H	5¼"	2¼"	460	1300	Type H - Post Terminals		
5MS004H	5¼"	3"	240	1700	Type H - Post Terminals		
5MS005H	5¼"	4½"	240	2400	Type H - Post Terminals		
5MS007H	5¼"	4½"	240	2700	Type H - Post Terminals		
5MS033H	5¼"	5"	230	2400	Type H - Post Terminals		
5MSA04I	5½-6"	1½"	480	800	Type I - 2 pc. Post Adjustable		
5MS014H	5¾"	1"	460	600	Type H - Post Terminals		
5MS012H*	5¾"	1½"	230	600	Type H - Post Terminals		
5MS043H	5¾"	1½"	240	1000	Type H - Post Terminals		
5MS035H	5¾"	1½"	460	1000	Type H - Post Terminals		
6MSA01I	6-6½"	1½"	480	850	Type I - 2 pc. Post Adjustable		

Call for Pricing 800-627-1033

Flex. Lds. = Flexible Leads

SS Lds. = Stainless Steel Leads

\*Indicates direct replacement for Van Dorn bands.



7925 N. Clinton St., Fort Wayne, IN 46825 USA • Web: [www.servicesforplastics.com](http://www.servicesforplastics.com) • E-mail: [sales@servicesforplastics.com](mailto:sales@servicesforplastics.com)  
Toll Free Phone: 800-627-1033 • Fax: 800-482-4059 • Local Phone: 260-482-9211 • Fax: 260-483-8139

# Standard Mica Heater Bands...continued

PART NO.	I.D.	WIDTH	TOTAL VOLTS	TOTAL WATTS	CONSTRUCTION TYPE	PRICE EACH	
						1-5	6-11+
6MS001I*	6"	1½"	230	1000	Type I - 2 pc. Post Terminals		
6MS002I	6"	1½"	480	900	Type I - 2 pc. Post Terminals		
6MS014H	6"	2½"	240	1400	Type H - Post Terminals		
6MSA02I	6-6½"	3"	480	1700	Type I - 2 pc. Post Adjustable		
6MSA03I	6½-7"	1½"	480	900	Type I - 2 pc. Post Adjustable		
6MS007H*	6¾"	1½"	230	815	Type H - Post Terminals		
6MS004H*	6¾"	1½"	230	600	Type H - Post Terminals		
6MS003H*	6¾"	1½"	230	1000	Type H - Post Terminals		
6MS005MSP*	6¾"	2½"	460	1150	Type M - 2 pc. Special 270° Coverage		
7MSA01I	7-7½"	1½"	480	1100	Type I - 2 pc. Post Adjustable		
7MS002H*	7½"	1½"	230	815	Type H - Post Terminals		
7MSA03I	7½-8"	1½"	240	850	Type I - 2 pc. Post Adjustable		
7MSA02I	7½-8"	1½"	480	1200	Type I - 2 pc. Post Adjustable		
7MS004H*	75/8"	3"	230	1800	Type H - Post Terminals		
7MS003H*	75/8"	3"	230	2000	Type H - Post Terminals		
8MSA01I	8-8½"	1½"	480	1300	Type I - 2 pc. Post Adjustable		
8MS002I*	8¼"	2"	220	1800	Type I - 2 pc. Post Terminals		
8MS003I*	8¼"	2"	440	1800	Type I - 2 pc. Post Terminals		
8MSA02I	8½-9"	1½"	480	1400	Type I - 2 pc. Post Adjustable		
8MS001I	8½"	3"	480	2000	Type I - 2 pc. Post Terminals		
9MSA01I	9-9½"	1½"	480	1500	Type I - 2 pc. Post Adjustable		
9MSA02I	9½-10"	1½"	240	1600	Type I - 2 pc. Post Adjustable		
9MS001H*	9½"	3"	240	2000	Type H - Post Terminals		
9MS002MSP*	9½"	3"	460	1930	Type M - 2 pc. Special 270° Coverage		
9MS003K*	9½"	6"	460	4000	Type K - 2 pc. Post Terminals		
10MSA01I	10-10½"	1½"	480	1700	Type I - 2 pc. Post Terminals		
11MS001KSP*	11¼"	3"	460	2400	Type K - 2 pc. Post Special		

Call for Pricing 800-627-1033

Flex. Lds. = Flexible Leads

SS Lds. = Stainless Steel Leads

\*Indicates direct replacement for Van Dorn bands.



If you don't see what you're looking for, please give us a call. We have many other heater bands available; plus we can special order your size, voltage, wattage, and/or lead configuration.

CALL TODAY FOR MORE INFORMATION ON

**800-627-1033**



# Economical Mica Heater Bands

**Economical Mica Heater Bands** are designed primarily for nozzle and narrow width sizes. The primary design difference between the economical and the standard mica bands is the thinness of the economical bands. This reduction in thickness not only contributes to the more economical pricing, but actually makes for a better heater (in the smaller sizes) by conforming more readily to the component being heated. Economical Mica Heater Bands are available with all of the standard options and designs available on our standard line of mica bands, and carry the same 1-year limited warranty.

PART NO.	I.D.	WIDTH	TOTAL VOLTS	TOTAL WATTS	CONSTRUCTION TYPE	PRICE EACH
1MA001B	1"	1"	120	100	Type B - 10" Flex. Lds.	Call for Pricing 800-627-1033
1MA002B	1"	1"	240	100	Type B - 10" Flex. Lds.	
1MA003B	1"	1½"	120	150	Type B - 10" Flex. Lds.	
1MA004B	1"	1½"	240	150	Type B - 10" Flex. Lds.	
1MA005B	1"	2"	120	200	Type B - 10" Flex. Lds.	
1MA006B	1"	2"	240	200	Type B - 10" Flex. Lds.	
1MA007B	1"	2½"	120	250	Type B - 10" Flex. Lds.	
1MA008B	1"	2½"	240	250	Type B - 10" Flex. Lds.	
1MA009B	1"	3"	120	300	Type B - 10" Flex. Lds.	
1MA010B	1"	3"	240	300	Type B - 10" Flex. Lds.	
1MA011B	1½"	1"	120	150	Type B - 10" Flex. Lds.	
1MA012B	1½"	1"	240	150	Type B - 10" Flex. Lds.	
1MA013B	1½"	1½"	120	275	Type B - 10" Flex. Lds.	
1MA014B	1½"	1½"	240	275	Type B - 10" Flex. Lds.	
1MA015A	1½"	1½"	120	275	Type A - 10" SS Lds.	
1MA016A	1½"	1½"	240	275	Type A - 10" SS Lds.	
1MA017B	1½"	2"	120	300	Type B - 10" Flex. Lds.	
1MA018B	1½"	2"	240	300	Type B - 10" Flex. Lds.	
1MA032C2	1½"	2¾"	240	400	Type C2 - 72" SS Lds.	
1MA033C2	1½"	2¾"	240	400	Type C2 - 96" SS Lds.	
1MA019B	1½"	2½"	120	400	Type B - 10" Flex. Lds.	
1MA020B	1½"	2½"	240	400	Type B - 10" Flex. Lds.	
1MA021B	1½"	3"	120	450	Type B - 10" Flex. Lds.	
1MA022B	1½"	3"	240	450	Type B - 10" Flex. Lds.	
1MA023B	1½"	3½"	120	525	Type B - 10" Flex. Lds.	
1MA024B	1½"	3½"	240	525	Type B - 10" Flex. Lds.	
1MA025B	1½"	4"	120	550	Type B - 10" Flex. Lds.	
1MA026B	1½"	4"	240	550	Type B - 10" Flex. Lds.	
1MA027B	1½"	5"	120	700	Type B - 10" Flex. Lds.	
1MA028B	1½"	5"	240	700	Type B - 10" Flex. Lds.	
1MA029B	1¾"	1½"	120	250	Type B - 10" Flex. Lds.	
1MA030B	1¾"	1½"	240	250	Type B - 10" Flex. Lds.	
2MA001B	2"	1"	120	200	Type B - 10" Flex. Lds.	
2MA002B	2"	1"	240	200	Type B - 10" Flex. Lds.	
2MA003B	2"	1½"	120	300	Type B - 10" Flex. Lds.	
2MA004B	2"	1½"	240	300	Type B - 10" Flex. Lds.	
2MA005B	2½"	1½"	120	350	Type B - 10" Flex. Lds.	
2MA006B	2½"	1½"	240	350	Type B - 10" Flex. Lds.	
3MA001B	3"	1½"	120	500	Type B - 10" Flex. Lds.	
3MA002B	3"	1½"	240	500	Type B - 10" Flex. Lds.	
3MA004H	3"	1½"	240	500	Type H - Post Terminals	
3MA005H13	3"	1½"	240-480	530	Type H - Post Terminals	
3MA003H	3"	2"	240	600	Type H - Post Terminals	
4MA001H	4"	2"	240	800	Type H - Post Terminals	
4MA002H13	4"	2"	240-480	835	Type H - Post Terminals	

Flex. Lds. = Flexible Leads      SS Lds. = Stainless Steel Leads





# Adjustable Mica Heater Bands

Adjustable 2-pc. Construction Allows Use Of This Band With A Variety Of I.D. Sizes

**A GOOD  
SUBSTITUTE FOR  
HARD-TO-FIND  
METRIC SIZES**

**FEATURES:**

- Easy On/Off -- Other Bands Do Not Need to be Removed for Installation
- Dual Voltage Options for Wiring Flexibility
- Special Barrel Nut Strap Adjusts to Fit a Wider Variety of I.D. Sizes

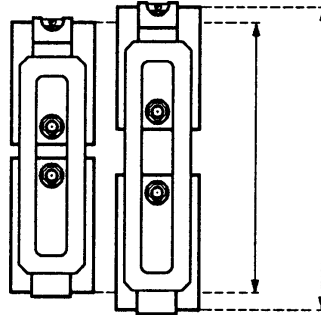

**ONE BAND  
adjusts to a variety  
of diameters!**



PART NO.	I.D.	WIDTH	VOLTS/ HALF	TOTAL WATTS	CONSTRUCTION TYPE	PRICE EACH	
					2-pc. Post	1-5	6-11+
4MSA01I	4 - 4½"	1½"	120	550	Type I	<b>Call for Pricing 800-627-1033</b>	
4MSA02I	4 - 4½"	1½"	240	550	Type I		
4MSA03I	4½ - 5"	1½"	120	650	Type I		
4MSA04I	4½ - 5"	1½"	240	650	Type I		
5MSA01I	5 - 5½"	1½"	120	700	Type I		
5MSA02I	5 - 5½"	1½"	240	700	Type I		
5MSA03I	5 - 5½"	3"	240	1400	Type I		
5MSA04I	5½ - 6"	1½"	240	800	Type I		
6MSA01I	6 - 6½"	1½"	240	850	Type I		
6MSA02I	6 - 6½"	3"	240	1700	Type I		
6MSA03I	6½ - 7"	1½"	240	900	Type I		
7MSA01I	7 - 7½"	1½"	240	1100	Type I		
7MSA02I	7½ - 8"	1½"	240	1200	Type I		
7MSA03I	7½ - 8"	1½"	120	850	Type I		
8MSA01I	8 - 8½"	1½"	240	1300	Type I		
8MSA02I	8½ - 9"	1½"	240	1400	Type I		
9MSA01I	9 - 9½"	1½"	240	1500	Type I		
9MSA02I	9½ - 10"	1½"	240	1600	Type I		
10MSA01I	10 - 10½"	1½"	240	1700	Type I		